

Notes:

All components 19mm (3/4 inch) timber.
 Mane and tail to be made from wool
 Grids are 50mm

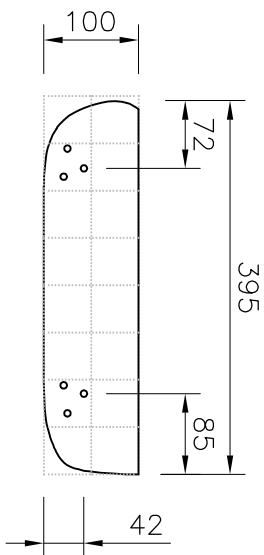

Body (2 Off) 50mm Grid

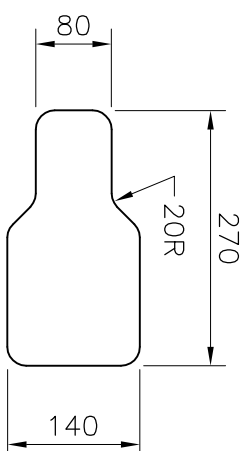

Seat (1 Off)

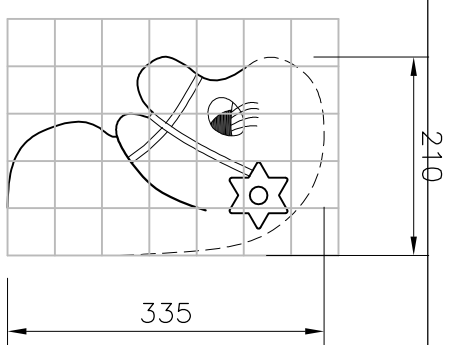

Head (1 Off)
 Mane not shown
 50mm Grid

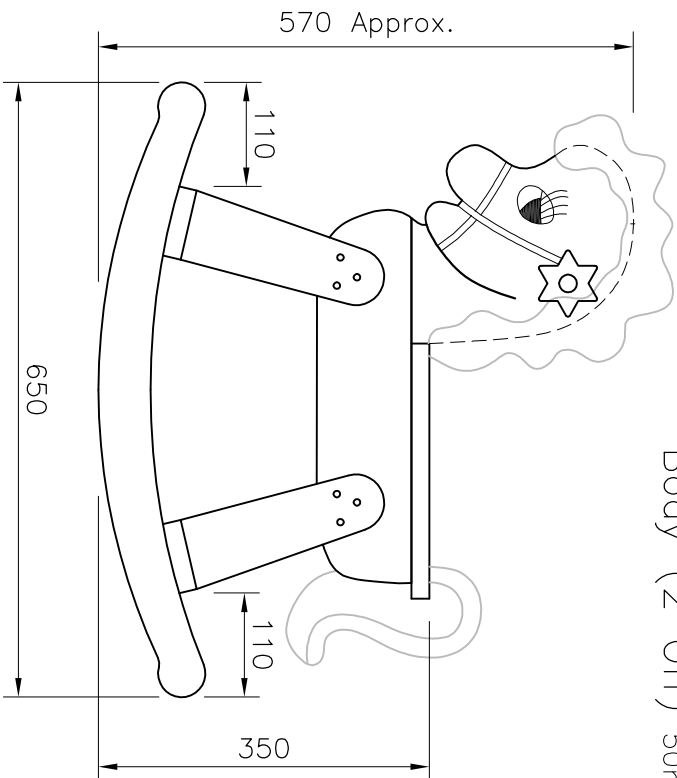

Side View

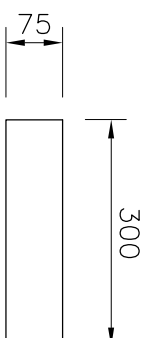

Spreader Bars (2 Off)

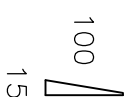

Wedges
 (4 pairs)

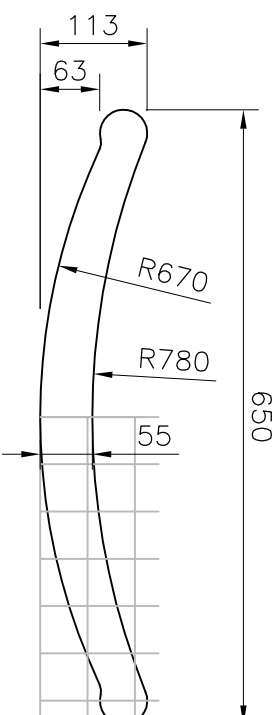

Rocker (2 Off) 50mm Grid

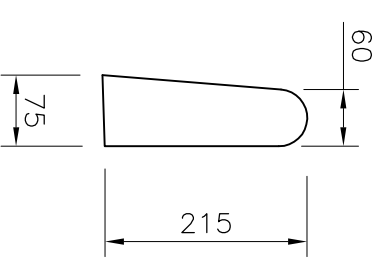

Legs (4 Off)

This work is licensed under the Creative Commons Attribution-NonCommercial 2.5 Australia License. To view a copy of this license, visit <http://creativecommons.org/licenses/by-nc/2.5/au/> or send a letter to Creative Commons, 171 Second Street, Suite 300, San Francisco, California, 94105, USA.

You are encouraged to freely copy and distribute this work without any amendments or changes.

Small Rocking Horse

WoodworkingDownunder.com

Sheet 1